

HX-EP SERIES

DIGITAL OUTPUT



Utilizing an incremental encoder as the sensor, the UniMeasure HX-EP series position transducer provides a two channel square wave current sinking output signal in quadrature. The standard output is a single-ended TTL compatible square. The resolution values shown in the specifications table indicate resolution for times 1 counting mode where a count is registered for one up transition in channel A. With interface electronics capable of times 2 or times 4 counting mode, a true resolutional increase of 2 or 4 may be obtained. For example, the HX-EP-50 has a resolution of approximately .004" per count in times 1 counting mode whereas the resolution is approximately .001" per count in times 4 counting mode.

The actual resolution of a HX-EP transducer differs from unit to unit because of tolerances associated with the wire rope diameter and the capstan upon which the wire rope winds. The nylon jacketed wire rope option will have the effect of slightly reducing the resolution. Linearity and repeatability remain independent of resolution. In applications where the output count is interpreted as a percentage of total travel, resolutional differences from unit to unit are not critical. However, in applications where the digital output is to be interfaced to a digital display to give an output in engineering units, the calibration constant supplied with the transducer may be used to calculate a suitable scale multiplier to produce the correct engineering units.

Alternative outputs shown in the Electrical Outputs table below are available to facilitate interfacing to a variety of different types of equipment.

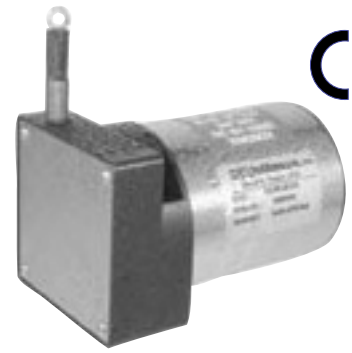

SPECIFICATIONS

General

Connector MS3102E-14S-6P
 Mating Connector (included)..... MS3106E-14S-6S
 Available Measurement Ranges See Supplemental Data¹, Table 12

Performance

Linearity ±0.03% Full Scale
 Repeatability ±0.015% Full Scale
 Resolution See Table 9

Electrical

Input Voltage +5 VDC ±5%
 Input Current 125 mA Maximum
 Output Two channel TTL square wave
 Phase Quadrature 90°±20°

Environmental

Operating temperature -20°C to +80°C
 Storage temperature -40°C to +100°C
 Shock 50 G's for 11 ms Duration
 Vibration 20 Hz to 2000 Hz @ 5G's
 Humidity 100%
 Ingress Protection
 Exclusive of Wire Rope Area NEMA 4 (IP-65)
 Optional Ingress Protection NEMA 6 (IP-68)

TABLE 9—RESOLUTION

MODEL	RANGE		RESOLUTION ¹		TOLERANCE ¹ ON RESOLUTION
	(inch)	(mm)	(counts/inch)	(counts/mm)	
HX-EP-10	10	250	500.0	19.69	±0.30%
HX-EP-25	25	640	250.0	9.84	±0.20%
HX-EP-50	50	1250	250.0	9.84	±0.20%
HX-EP-60	60	1.5 m	205.8	8.10	±0.20%
HX-EP-80	80	2.0 m	155.2	6.11	±0.20%
HX-EP-100	100	2.5 m	82.9	3.26	±0.20%
ALL RANGES GREATER THAN 100"	100	2.5 m	82.9	3.26	±0.20%

NOTES

1. The resolution shown is a calculated number based upon the capstan diameter, wire rope diameter and line count of the encoding device. The tolerance on the resolution accounts for resolutional differences from unit to unit due to manufacturing tolerances on the capstan and wire rope. In practice, the output count in a given unit of travel is an integer.

ELECTRICAL OUTPUT

For electrical output description, waveform and wiring, See Supplemental Data, TABLE 8

FOOTNOTES TO SPECIFICATIONS

1. Supplemental Data section located at end of HX Series pages.

Model Number Configuration

HX-EP- - - - -

Range
 Select measurement range from Supplemental Data, Table 12, Insert corresponding Measurement Range Designator

Wire Rope
 * Stainless Steel (See Supplemental Data, Table 12)
NJC Ø.018 (0,45 mm) Nylon Jacketed Stainless Steel Ranges to 80" (2m) only.
NJC037 Ø.037 (0,94 mm) Nylon Jacketed Stainless Steel Ranges 100" (2.5m) to 500" (12.7m) only.

Wire Rope Tension
 * Standard
004 Reduced (Ranges to 80" only)

Wire Rope Exit Direction
 * Top Exit
E1 Side Exit (Left)
E2 Side Exit (Right)
E3 Bottom Exit

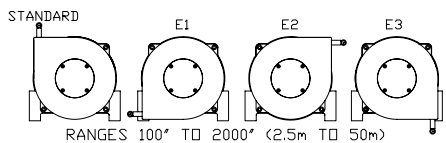

Housing
 * NEMA 4 (IP-65) Aluminum
N6 NEMA 6 (IP-68) Aluminum
SS NEMA 6 (IP-68) Corrosion Resistant Stainless Steel and Non-Metallic Construction



Electrical Interface
 * Mating Connector Included (See note 1 below)
L3M 3 m (10') electrical cable (See note 2 below)
L4M 4 m (13.5') electrical cable (See note 2 below)
L5M 5 m (16.5') electrical cable (See note 2 below)
L6M 6 m (20') electrical cable (See note 2 below)
L7M 7 m (23') electrical cable (See note 2 below)
 1. Applies to NEMA 4 Housing option only. Does not apply to N6 or SS Housing options.
 2. Select one of options L3M through L7M when electrical cable is required with mating connector when Housing option NEMA 4 is also selected. Select one of options L3M through L7M when Housing option N6 or SS is selected. Connector is **not** available with Housing option N6 or SS.

Electrical Output (See Supplemental Data, TABLE 8, Page 22.)
 * Standard 2 channel 5 VDC, TTL
I 2 channel 5 VDC, TTL with Index
H1 8 to 28 VDC Current Sinking
H1I 8 to 28 VDC Current Sinking with Index
H2 5 VDC Current Sinking Differential Line Drive
H2I 5 VDC Current Sinking Differential Line Drive with Index
H3 8 to 28 VDC Current Sinking Differential Line Drive
H3I 8 to 28 VDC Current Sinking Differential Line Drive with Index
H4 8 to 28 VDC Push-Pull Differential Line Drive
H4I 8 to 28 VDC Push-Pull Differential Line Drive with Index
H5 5 VDC Push-Pull Differential Line Drive
H5I 5 VDC Push-Pull Differential Line Drive with Index
 Note: H2I, H3I, H4I and H5I options are only available with NEMA 4 (IP-65) housing configuration with connector and mating connector and **NO** electrical cable.

NOTE
 1) *—Asterisk items are standard configuration. No option designator is required.
 2) Shaded options available at additional cost.
 3) See Supplemental Data for options.

Example
HX-EP-50-NJC-H1

ADDITIONAL OPTIONS

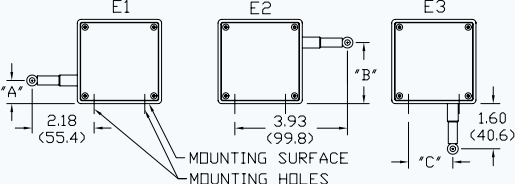
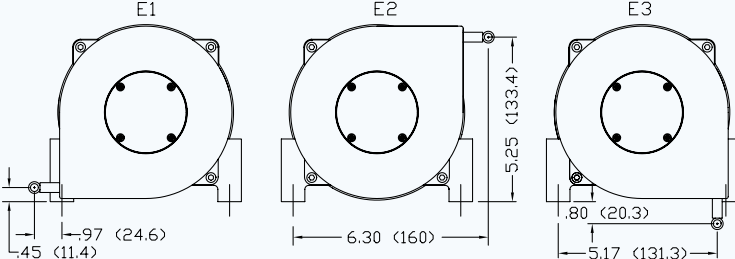
OPTION	OPTION DESIGNATOR	DESCRIPTION																												
Nylon jacketed wire rope (Ranges to 80" only)	NJC	Replaces standard stainless steel wire rope with Ø.018 nylon jacketed wire rope. This option increases wire rope life dramatically but may increase non-linearity by as much as ±.05% of full scale.																												
Nylon jacketed wire rope (Ranges 100" to 500" only)	NJC037	Replaces standard stainless steel wire rope with Ø.037 nylon jacketed wire rope.																												
Reversed output	R	Output is at a maximum when wire rope is fully retracted. Output decreases as wire rope is extended. Does not apply to velocity signal.																												
NEMA 6, IP-68 capability	N6	 <p>Connector is replaced with a bulkhead fitting and a designated length of urethane jacketed, shielded, twisted pair cable. Retraction mechanism and electrical components are sealed to NEMA 6, IP-68 capability. No connector.</p>																												
Corrosion Resistant Construction	SS	<p>All external anodized aluminum parts of transducer are replaced with stainless steel and corrosion resistant plastic. Transducer is sealed to NEMA 6, IP-68 capability. Urethane jacketed, shielded, twisted pair cable exits unit. No connector.</p> 																												
Non-standard potentiometer (Applies to HX-PA only)	PXK	<p>Replace "X" in option designator with required potentiometer value in K ohms. Non-standard potentiometer linearity is as follows:</p> <p>Ranges 0 to 2" to 0 to 5" ±1.00% of full scale Ranges 0 to 10" to 0 to 25" ±0.50% of full scale Ranges 30" and above ±0.25% of full scale Note: This option is subject to potentiometer availability.</p>																												
Alternate wire rope exit Measurement ranges to 80" (2.0 m)	E1, E2, E3	 <table border="1"> <thead> <tr> <th>RANGE</th> <th>"A"</th> <th>"B"</th> <th>"C"</th> </tr> </thead> <tbody> <tr> <td>2", 10"</td> <td>1.12 (28.4)</td> <td>1.79 (45.5)</td> <td>1.21 (30.7)</td> </tr> <tr> <td>3", 15", 30"</td> <td>.96(24.4)</td> <td>1.95 (49.5)</td> <td>1.37 (34.8)</td> </tr> <tr> <td>4", 20", 40"</td> <td>.80 (20.3)</td> <td>2.11 (53.6)</td> <td>1.53 (38.9)</td> </tr> <tr> <td>5", 25", 50"</td> <td>.64 (16.3)</td> <td>2.27 (57.7)</td> <td>1.69 (42.9)</td> </tr> <tr> <td>6", 60"</td> <td>.49 (12.4)</td> <td>2.42 (61.5)</td> <td>1.84 (46.7)</td> </tr> <tr> <td>80"</td> <td>.25 (6.4)</td> <td>2.66 (67.6)</td> <td>2.08 (52.8)</td> </tr> </tbody> </table> <p>Dimensions in brackets are millimeters.</p>	RANGE	"A"	"B"	"C"	2", 10"	1.12 (28.4)	1.79 (45.5)	1.21 (30.7)	3", 15", 30"	.96(24.4)	1.95 (49.5)	1.37 (34.8)	4", 20", 40"	.80 (20.3)	2.11 (53.6)	1.53 (38.9)	5", 25", 50"	.64 (16.3)	2.27 (57.7)	1.69 (42.9)	6", 60"	.49 (12.4)	2.42 (61.5)	1.84 (46.7)	80"	.25 (6.4)	2.66 (67.6)	2.08 (52.8)
RANGE	"A"	"B"	"C"																											
2", 10"	1.12 (28.4)	1.79 (45.5)	1.21 (30.7)																											
3", 15", 30"	.96(24.4)	1.95 (49.5)	1.37 (34.8)																											
4", 20", 40"	.80 (20.3)	2.11 (53.6)	1.53 (38.9)																											
5", 25", 50"	.64 (16.3)	2.27 (57.7)	1.69 (42.9)																											
6", 60"	.49 (12.4)	2.42 (61.5)	1.84 (46.7)																											
80"	.25 (6.4)	2.66 (67.6)	2.08 (52.8)																											
Alternate wire rope exit Measurement ranges 100" (2.5 m) and greater.	E1, E2, E3	 <p>Dimensions in brackets are millimeters.</p>																												

Specifications subject to change without notice.

ADDITIONAL SPECIFICATIONS

TABLE 8

EP, HX-EP Series Optional Electrical Outputs

Option	Output Description	Output Stage	Waveform	Connector Wiring																
I	Index Channel Adds index (Z) channel. Index is triggered within the first 0.25" (6 mm) of extension of the wire rope. Triggers repeatedly for each complete rotation of the internal capstan.			<table border="1"> <tr><td>A</td><td>+Vin</td></tr> <tr><td>B</td><td>COMMON</td></tr> <tr><td>C</td><td>CHANNEL A</td></tr> <tr><td>D</td><td>CHANNEL B</td></tr> <tr><td>E</td><td>CHANNEL Z</td></tr> <tr><td>F</td><td></td></tr> </table>	A	+Vin	B	COMMON	C	CHANNEL A	D	CHANNEL B	E	CHANNEL Z	F					
A	+Vin																			
B	COMMON																			
C	CHANNEL A																			
D	CHANNEL B																			
E	CHANNEL Z																			
F																				
H1	8 to 28 VDC Current Sinking Current sinking output with 10KΩ internal pullup resistors		Z information applies to "I" & "H1" options only.	Z information applies to "I" & "H1" options only.																
H1I	8 to 28 VDC input voltage. "H1I" is same as "H1" option but adds the index (Z) channel.																			
H2	5 VDC TTL Current Sinking Differential Line Drive Current sinking line drive output with 2KΩ internal pullup resistors. 5 VDC input voltage.			<table border="1"> <tr><td>A</td><td>+Vin</td></tr> <tr><td>B</td><td>COMMON</td></tr> <tr><td>C</td><td>CHANNEL A</td></tr> <tr><td>D</td><td>CHANNEL A-bar</td></tr> <tr><td>E</td><td>CHANNEL B</td></tr> <tr><td>F</td><td>CHANNEL B-bar</td></tr> <tr><td>G</td><td>CHANNEL Z</td></tr> <tr><td>H</td><td>CHANNEL Z-bar</td></tr> </table>	A	+Vin	B	COMMON	C	CHANNEL A	D	CHANNEL A-bar	E	CHANNEL B	F	CHANNEL B-bar	G	CHANNEL Z	H	CHANNEL Z-bar
A	+Vin																			
B	COMMON																			
C	CHANNEL A																			
D	CHANNEL A-bar																			
E	CHANNEL B																			
F	CHANNEL B-bar																			
G	CHANNEL Z																			
H	CHANNEL Z-bar																			
H2I	"H2I" is same as "H2" option but adds the index (Z) channel.																			
H3	8 to 28 VDC Current Sinking Differential Line Drive Current sinking line drive output with 10KΩ internal pullup resistors. 8 to 28 VDC input voltage.		Z & Z-bar information applies to H2I, H3I, H4I, & H5I options only.	Z & Z-bar information applies to H2I, H3I, H4I, & H5I options only.																
H3I	"H3I" is same as "H3" option but adds the index (Z) channel.																			
H4	8 to 28 VDC Push-Pull Differential Line Drive Push-Pull, current sourcing and current sinking output. 8 to 28 VDC input voltage.		Z & Z-bar information applies to H2I, H3I, H4I, & H5I options only.	Z & Z-bar information applies to H2I, H3I, H4I, & H5I options only.																
H4I	"H4I" is same as "H4" option but adds the index (Z) channel.																			
H5	5 VDC Push-Pull Differential Line Drive Push-Pull, current sourcing and current sinking output. 5 VDC input voltage. Output is compliant with requirements of TIA/EIA-422-B.		Z & Z-bar information applies to H2I, H3I, H4I, & H5I options only.	Z & Z-bar information applies to H2I, H3I, H4I, & H5I options only.																
H5I	H5I is same as H5 option but adds the index (Z) channel.																			

HX SERIES

SUPPLEMENTAL DATA

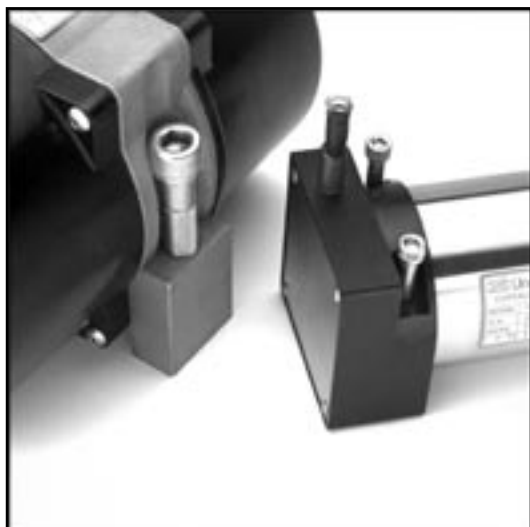

Typical HX mounting bolts.

MECHANICAL SPECIFICATIONS

Mechanical Specifications

- Available Measurement Ranges.....See Table 12
- Construction
 - Ranges 80" (2 m) and under.....Anodized Aluminum Mounting Base, Stainless Steel & Anodized Aluminum Housing
 - Ranges 100" (2.5 m) and greaterStainless Steel Mounting Base High Impact, Corrosion Resistant Thermoplastic Housings
- Wire Rope TensionSee Table 12
- Wire Rope Diameter.....See Table 12
- WeightSee Table 12
- Connector.....MS3102A-14S-6P
- Mating Connector (included).....MS3106E-14S-6S
- Optional NEMA 6 Capability.....Bulkhead fitting with shielded, twisted pair cable
- Life*
 - Ranges 2" to 6"5,000,000 full stroke cycles
 - Ranges 10" to 25"500,000 full stroke cycles
 - Ranges 30" to 400"250,000 full stroke cycles
 - Ranges 500" to 2000"200x10⁶ lineal inches

* with 1K ohm potentiometer, wire rope misalignment 2° maximum at full stroke, relatively dust free environment, nylon jacketed wire rope on units with ranges 80" and less.

Use value from this column to indicate overall measurement range

Check mark indicates available measurement range

TABLE 12

MEASUREMENT RANGE DESIGNATOR	STANDARD MEASUREMENT RANGES		APPLICABLE SERIES			WIRE ROPE TENSION (NOMINAL)		WIRE ROPE DIAMETER		TRANSDUCER WEIGHT		Product Photo	
	(in)	(mm)	HX-PA HX-PB HX-P420 HX-P510 HX-P1010	HX-EP	HX-V HX-VP	(oz)	(N)	(in)	(mm)	(lb)	(Kg)		
2	2	50	✓	-	✓	34	9.4	.016	0.4	2	0.9		
3	3	75	✓	-	✓	24	6.7	.016	0.4	2	0.9		
4	4	100	✓	-	✓	24	6.7	.016	0.4	2	0.9		
5	5	125	✓	-	✓	19	5.3	.016	0.4	2	0.9		
6	6	150	✓	-	✓	24	6.7	.016	0.4	2	0.9		
10	10	250	✓	✓	✓	34	9.4	.016	0.4	2	0.9		
15	15	390	✓	-	✓	24	6.7	.016	0.4	2	0.9		
20	20	500	✓	-	✓	24	6.7	.016	0.4	2	0.9		
25	25	640	✓	✓	✓	19	5.3	.016	0.4	2	0.9		
30	30	750	✓	-	✓	24	6.7	.016	0.4	2	0.9		
40	40	1000	✓	-	✓	24	6.7	.016	0.4	2	0.9		
50	50	1250	✓	✓	✓	19	5.3	.016	0.4	2	0.9		
60	60	1500	✓	✓	✓	24	6.7	.016	0.4	2	0.9		
80	80	2.0m	✓	✓	✓	21	5.8	.016	0.4	2	0.9		
100	100	2.5m	✓	✓	✓	36	10.0	.024	0.6	6.8	3.1		
120	120	3.0m	✓	✓	✓	36	10.0	.024	0.6	6.8	3.1		
150	150	3.8m	✓	✓	✓	36	10.0	.024	0.6	6.8	3.1		
200	200	5.0m	✓	✓	✓	36	10.0	.024	0.6	6.8	3.1		
250	250	6.3m	✓	✓	✓	36	10.0	.024	0.6	6.8	3.1		
300	300	7.5m	✓	✓	✓	36	10.0	.024	0.6	6.8	3.1		
350	350	8.8m	✓	✓	✓	36	10.0	.024	0.6	6.8	3.1		
400	400	10.0m	✓	✓	✓	36	10.0	.024	0.6	6.8	3.1		
500	500	12.5m	✓	✓	✓	36	10.0	.024	0.6	8.6	3.9		
600	600	15.2m	✓	✓	✓	36	10.0	.024	0.6	8.6	3.9		
800	800	20.3m	✓	✓	✓	36	10.0	.024	0.6	8.6	3.9		
1000	1000	25.4m	✓	✓	-	36	10.0	.024	0.6	12.0	5.4		
1200	1200	30.4m	✓	✓	-	36	10.0	.024	0.6	12.3	5.6		
1600	1600	40.6m	✓	✓	-	36	10.0	.024	0.6	14.1	6.4		
1800	1800	45.7m	✓	✓	-	36	10.0	.021	0.6	15.9	7.2		
2000	2000	50.8m	✓	✓	-	36	10.0	.021	0.5	16.3	7.4		

Specifications subject to change without notice.

DIMENSIONAL INFORMATION

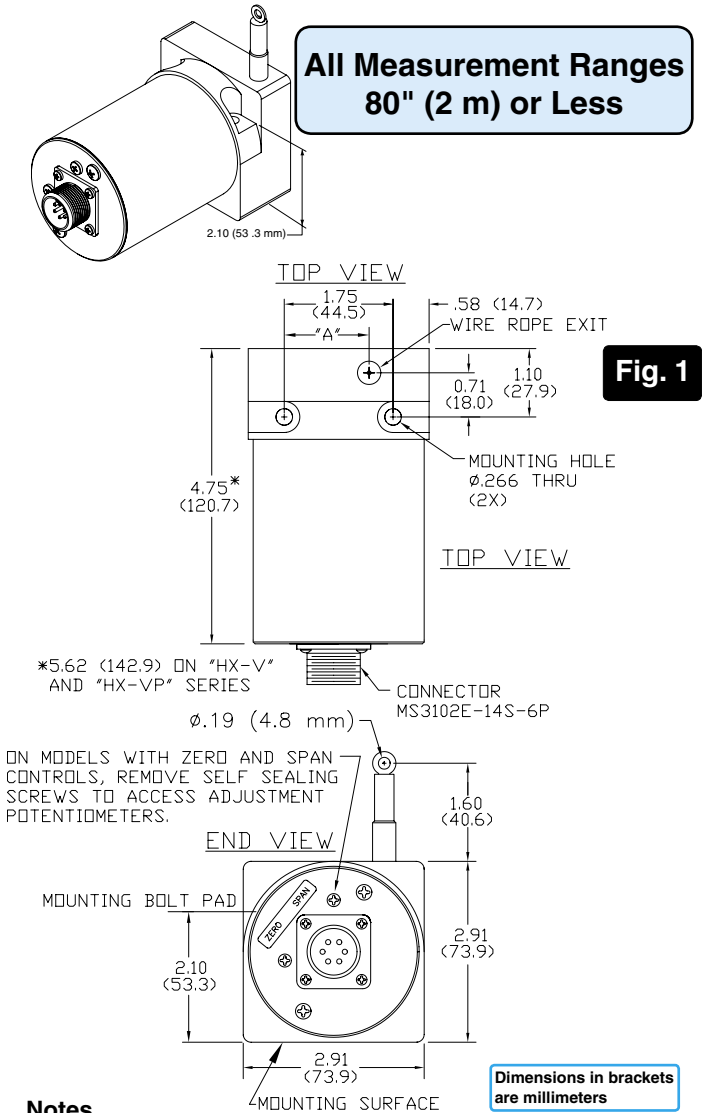

Notes

1. Transducer mounts with Ø.25 or M6 socket head cap bolts.

Table 13

RANGE	"A"
2", 10"	1.21 (30.7)
3", 15", 30"	1.37 (34.8)
4", 20", 40"	1.53 (38.9)
5", 25", 50"	1.69 (42.9)
60"	1.84 (46.7)
80"	2.08 (52.8)

Table 14

RANGE	DIM "A"	DIM "B"
Ranges to 800"	7.70 (196)	3.80 (97)
1000" to 2000"	11.0 (280)	5.60 (142)

Notes

1. Transducer mounts with Ø.50 or M12 socket head cap bolts.
2. Dimension "C" is the cable offset that occurs as the cable is extended from the transducer.

For "C" in inches, $C = .0016 \times E$ where E = extension in inches.

For "C" in millimeters, $C = .0016 \times E$ where E = extension in mm.

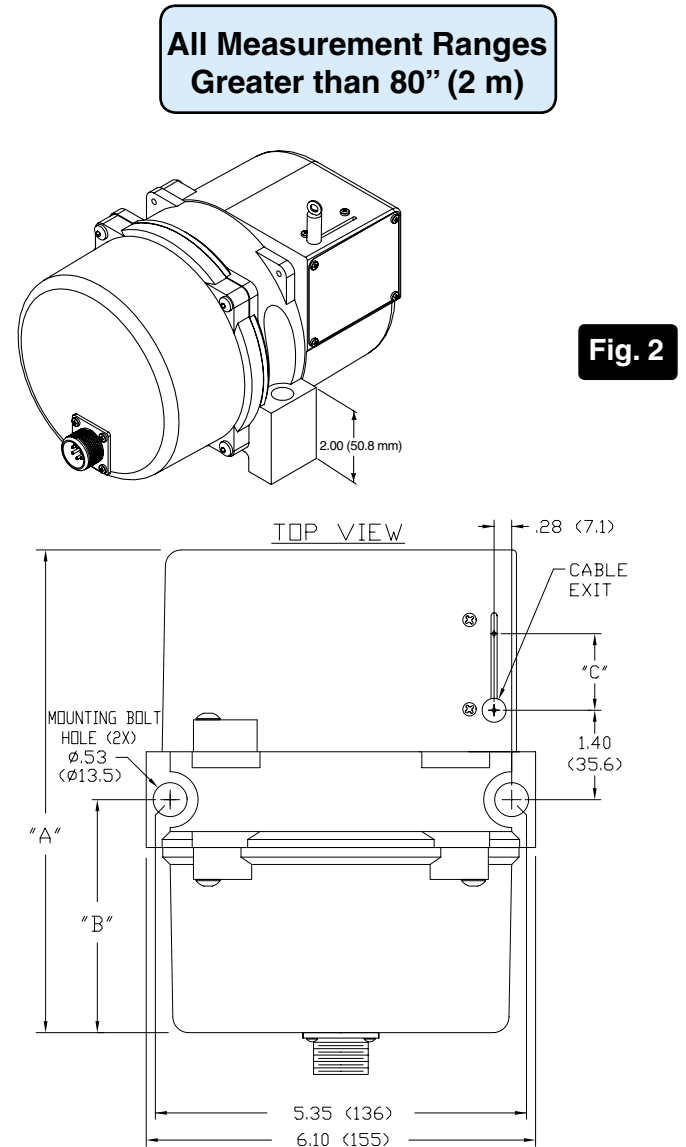

Dimensions in brackets are millimeters

Specifications subject to change without notice.